

HeadQuarters

3rd U.S. Regular Infantry

Write-up: JP Tate
Diagrams: KB Skaggs

Objective:

This monograph explains the techniques and orders for forming and reducing a square.

Background:

The infantry square is most easily formed from a column of double companies. It can be formed from a line of battle but in the interest of brevity and to make it easier on the officers, I have focused on this technique for forming the square. The square is the strongest defense of infantry against cavalry. However, it is immobile and can be devastated by artillery. Thus, when cavalry is attacking, the infantry should form the square. If artillery fires on the square it should be reduced and the infantry moved to a safe location. Fortunately, cavalry and artillery can't attack at the same time.

It should be noted that each side of the square is named as a "front". The side closest to the enemy is the first front. The side at the rear of the square is the fourth front. The side to the left of the square is the third front and the side to the right of the square is the second front.

All references are to Casey's System of Infantry Tactics authorized by the War Department in 1862, unless otherwise noted. The diagrams are numbered as in Casey's Manual.

To deploy the battalion into double column on the center companies: These commands are given when the battalion is halted. The battalion is in line of battle and forms a double column of companies. When this maneuver is completed the battalion will be in a column of companies with the center two companies at the head of the column.

1. Double column, at half distance. 2. Battalion inward---- FACE 3. MARCH (Casey's School of the Battalion, para 875.)

The left wing companies face to the right and the right wing companies face to the left. Although it isn't noted in the manual, each company commander must give the command "Break three files to the rear" before his company can march to the rear to form the divisions in column.

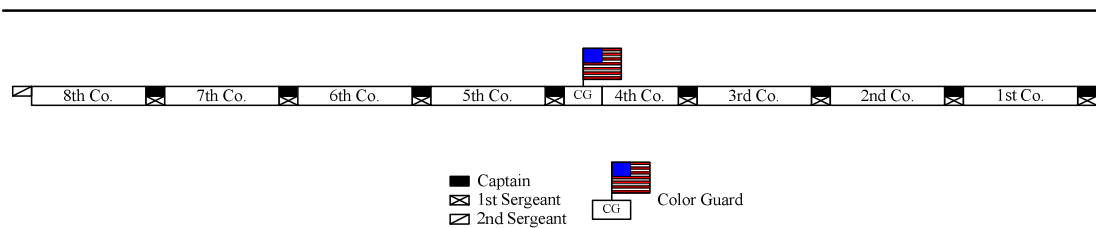

Figure 1: Battalion in Line of Battle

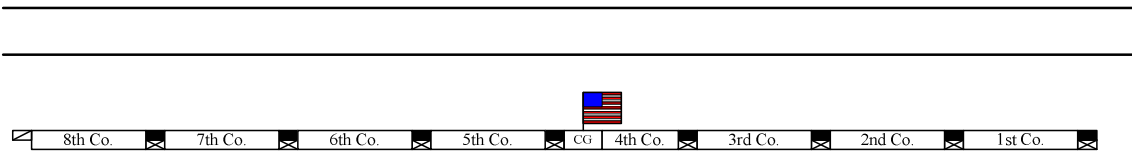

Figure 2: "Double column, at half distance."

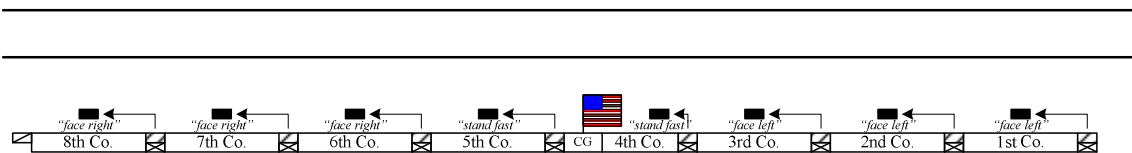

Figure 3

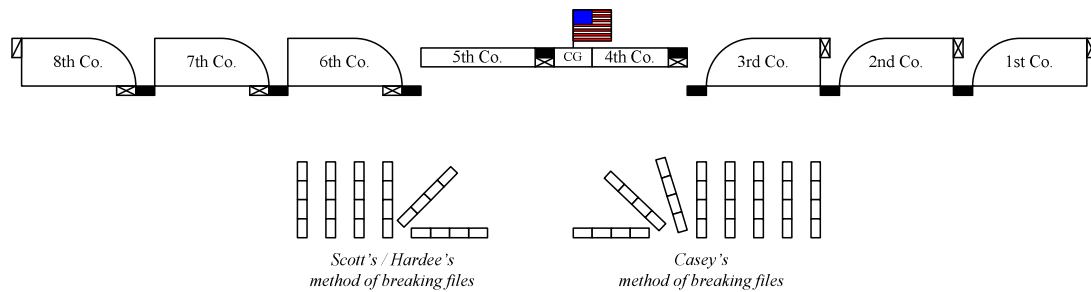

Figure 4: "Battalion, inward - FACE."

If the battalion is marching in line of battle and must form double column while continuing to march, the commands are slightly different.

1. Double column at half distance
 2. Battalion by the right and left flanks
 3. MARCH
- (Casey's School of the Battalion, para 889)

The movements of the companies are the same while marching as they were when the battalion was at a halt. The only difference is that the battalion never stops marching in this instance. Refer to the first diagram for the movements of the companies.

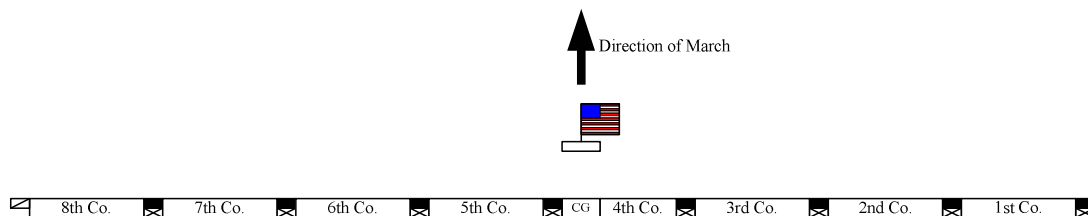

Figure 6:

1. "Double column, at half distance."
2. "Battalion, by the right and left flanks."
3. "MARCH."

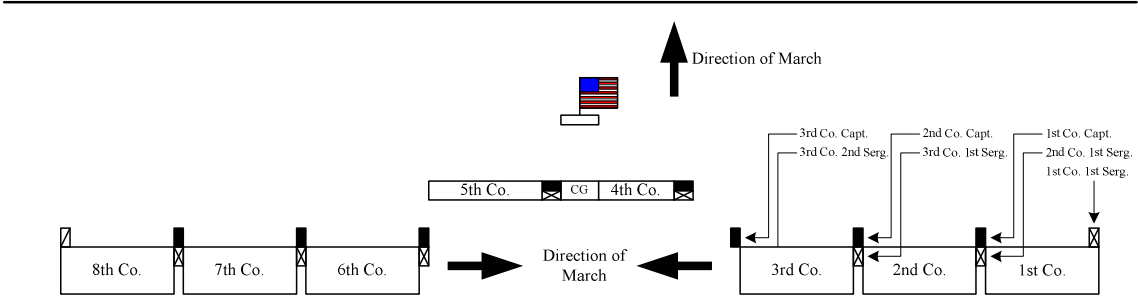

Figure 7

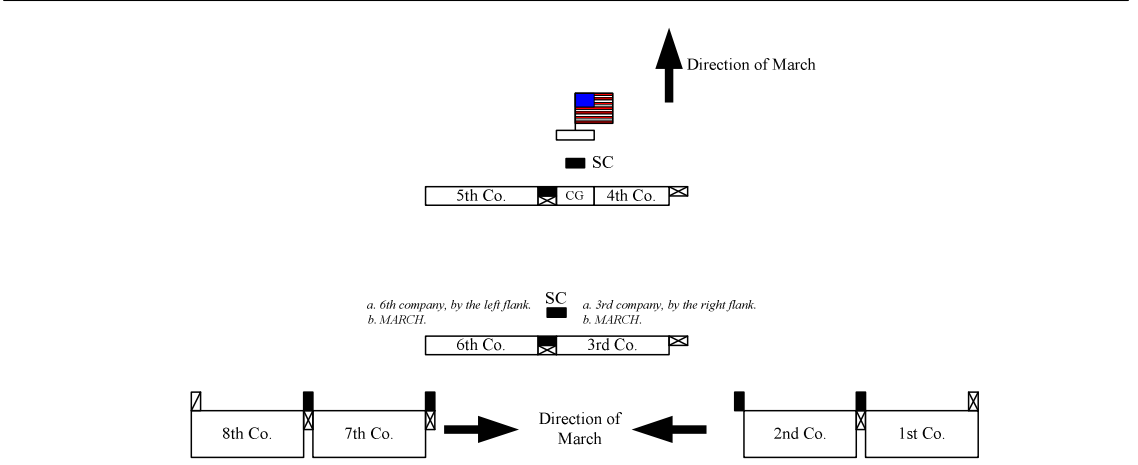

Figure 8

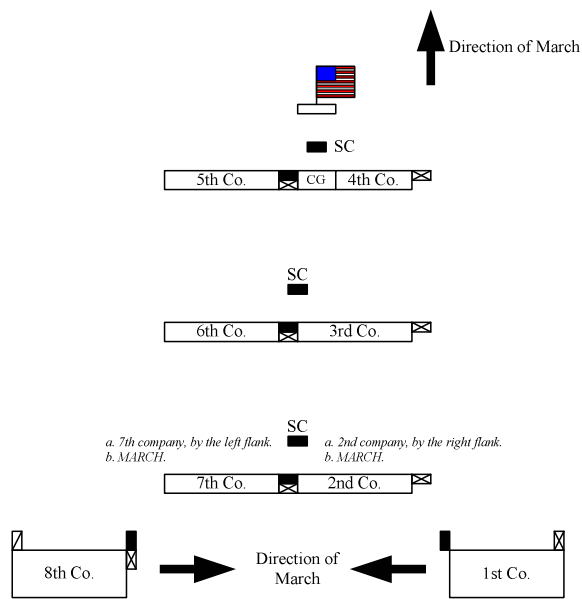

Figure 9

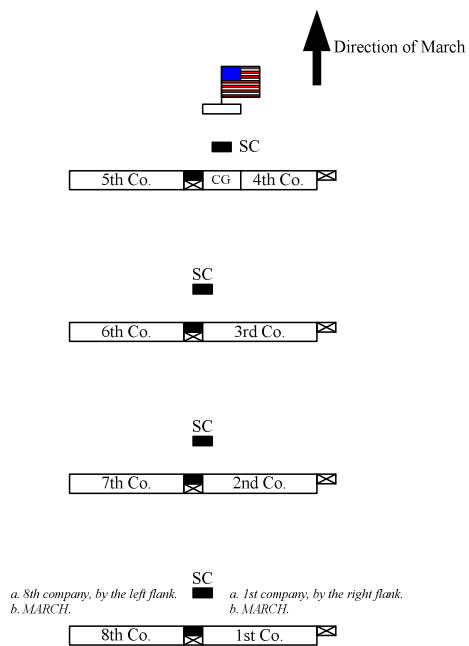

Figure 10

A double column of companies can also be formed from a column of companies. Because the double column is formed with the two center companies at the head, it is necessary to turn the right wing of the battalion backward on the column to join the left wing.

When the battalion is in a column of companies and the colonel wishes to form a double column on the center companies, the commands are as noted below. The battalion commander will order:

1. Form Double column
 2. Right wing, right FACE
 3. MARCH
- (Casey's School of the Battalion, para 982)

The right wing companies (the first 4 companies in the battalion column of companies) face to the right. Then under the company commander's direction, they march by the right flank until each company is clear of the column of the left wing companies. They then face to the rear and march toward the back of the column with each company in succession, joining its left wing partner. When the right wing companies have reached their proper partner in the double column, the company commander will face them to the front of the column and dress on their left wing company partner.

There is no detailed set of commands for the right wing company commanders to move their units into the new formation. My interpretation of the maneuvers is based on the diagram. The fourth company will join the fifth company in the first division of the double column. The fourth company commander will command:

1. Right FACE, 2. MARCH

He will take a position next to his directing sergeant at the first command and will stay in place as he moves the company forward (marching by the right flank). When the left guide comes even with him, the fourth company commander will command:

1. By the Right flank, 2. MARCH

This will have the company marching by the rear rank (the men must un-double in this maneuver). The company will march to a point just behind a line of the fifth company. At this point the fourth company will be commanded:

1. Right About, 2. HALT

The company will be faced to the front and the commander will dress the company on the fifth company.

The third, second and first companies will also march by the right flank until they are past the right flank of the fourth company. At this time each company commander will command:

2. By the Right flank, 2. MARCH

This will have the company marching by the rear rank (the men must un-double in this maneuver). Each company will march until they reach a point just behind their division partner. Rather than have each company (still marching by the rear rank) make a right flank maneuver; it would probably be better to have each succeeding company make a "Right About, HALT" move and then march by the left flank to its position next to its partner. The first company will have the longest distance to march.

This is a long and tedious maneuver and the battalion commander must give his companies time to move to their proper positions.

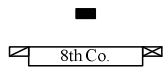
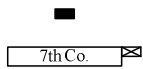
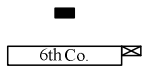
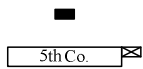
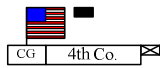
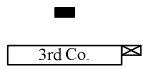
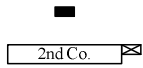
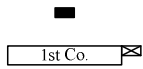

Figure 11
1. "Form Double column."
2. "Right wing, right FACE."
3. "MARCH."

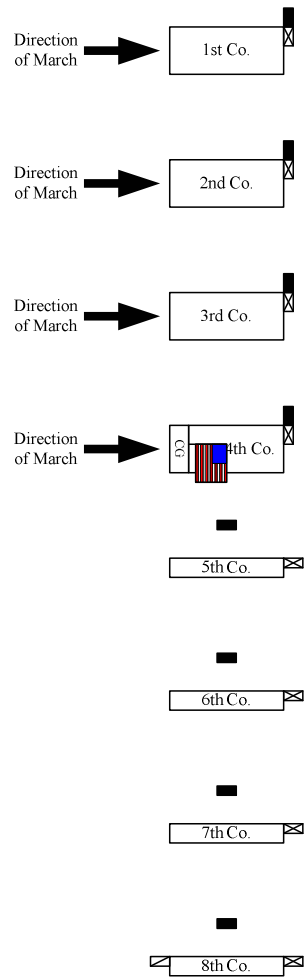

Figure 12

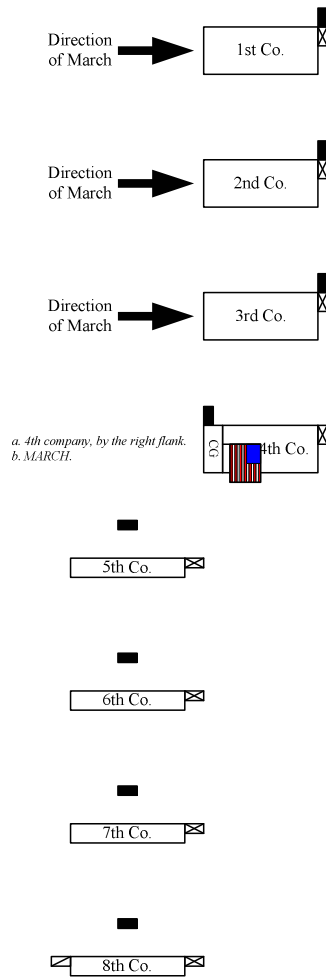

Figure 13

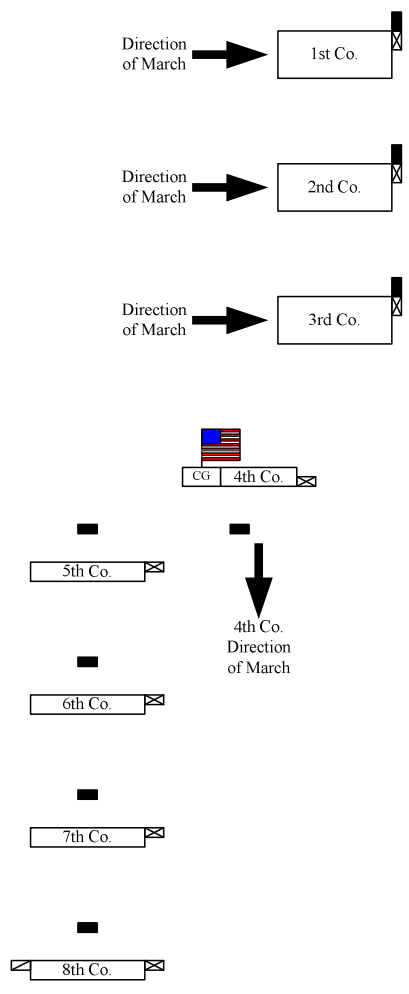
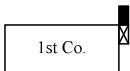
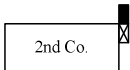

Figure 14

a. 1st company, by the right flank.
b. MARCH.



a. 2nd company, by the right flank.
b. MARCH.



a. 3rd company, by the right flank.
b. MARCH.

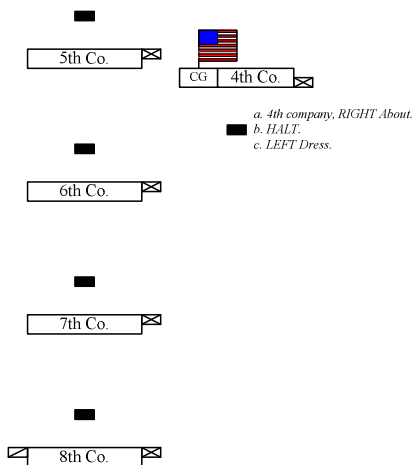
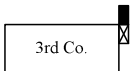

a. 4th company, RIGHT About.
b. HALT.
c. LEFT Dress.

Figure 15

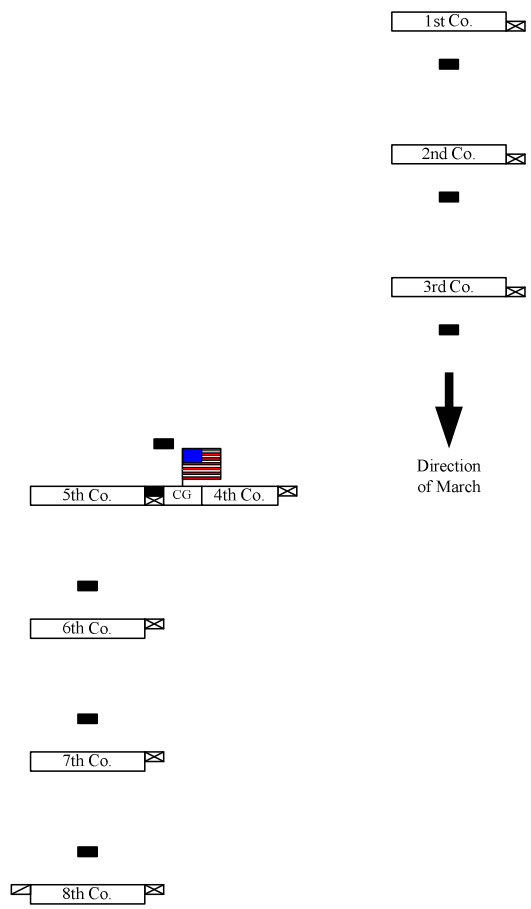

Figure 16

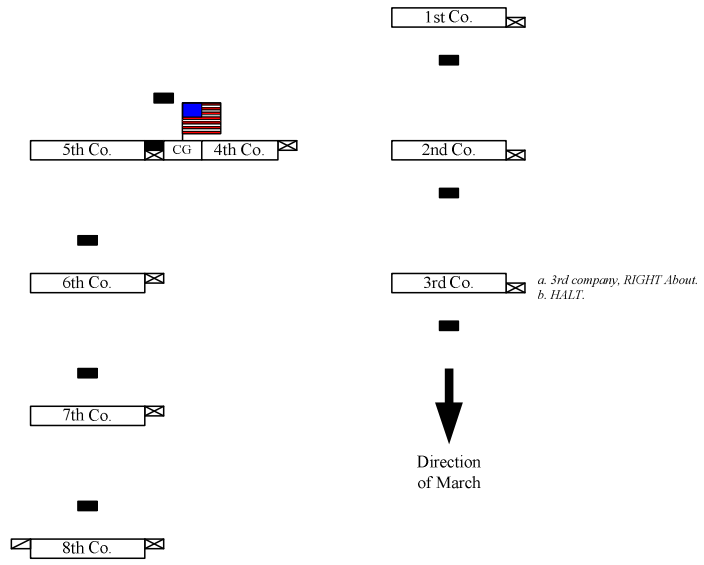

Figure 17

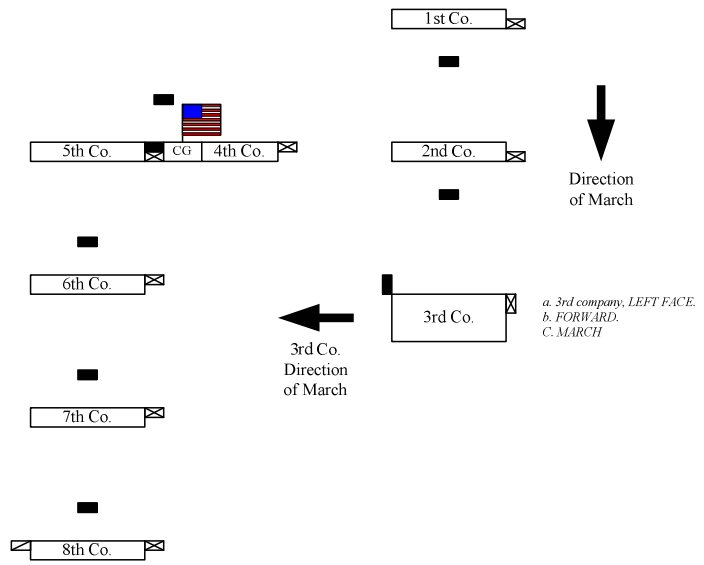

Figure 18

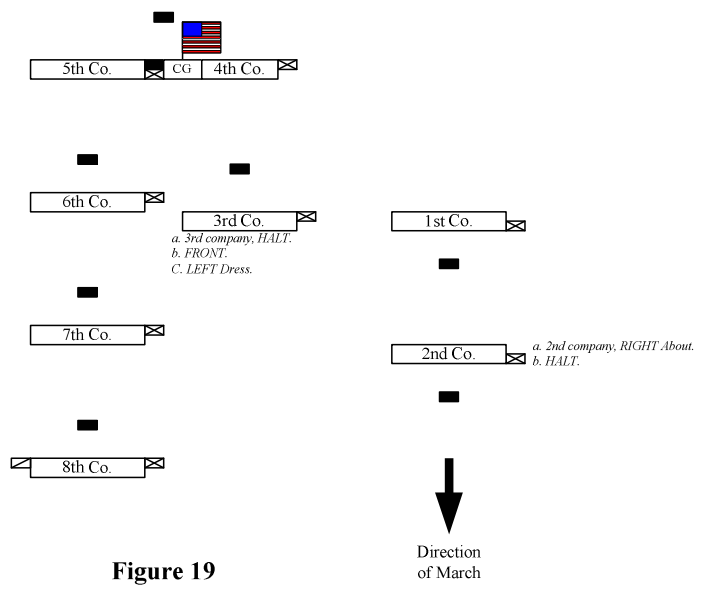

Figure 19

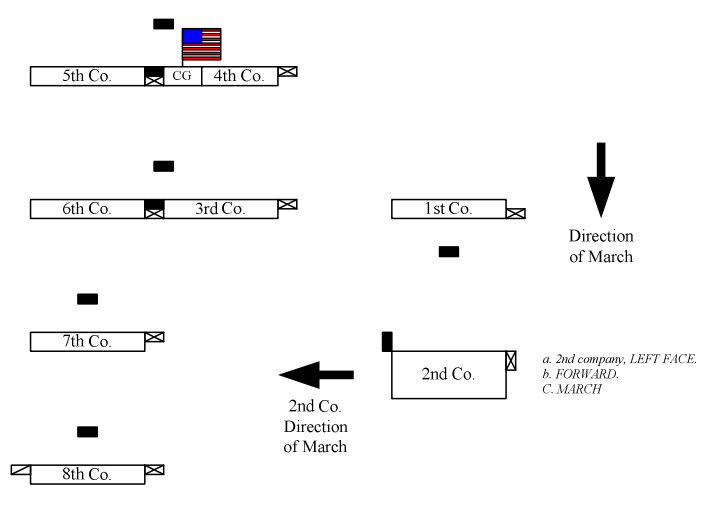

Figure 20

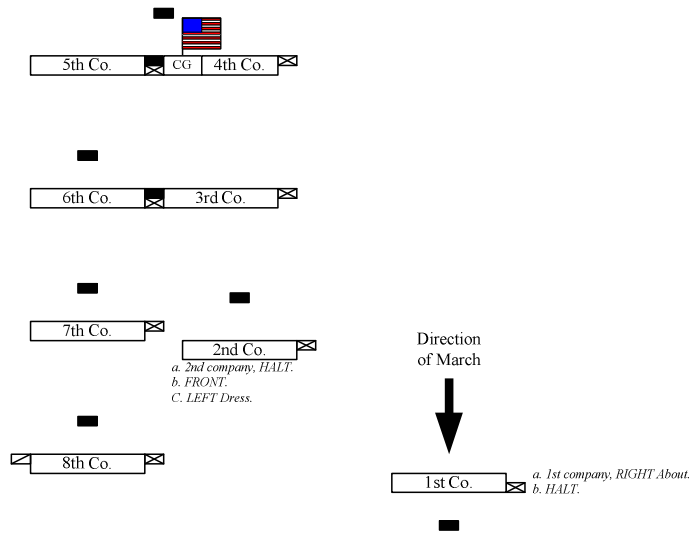

Figure 21

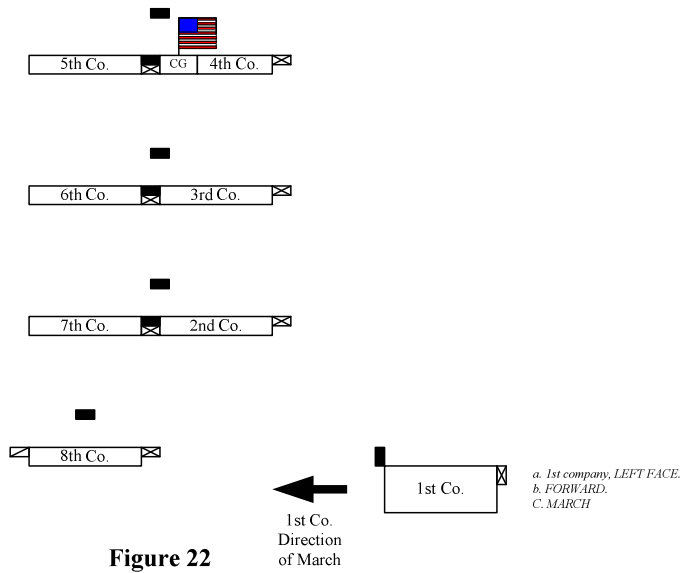

Figure 22

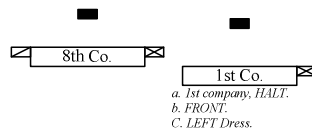
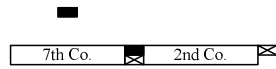
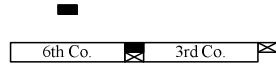
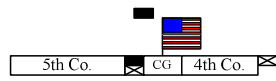

Figure 23

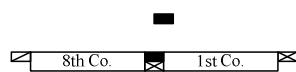
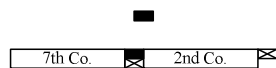
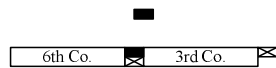
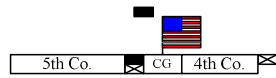

Figure 24

Now that we have the battalion formed in a double column of companies, it can form a square.

To form a square against cavalry from a double column of companies the battalion commander issues the following order:

1. Form Square.
2. Right and left into line, WHEEL

The companies of the first division, now the first front, will be cautioned by the division commander to stand fast.

The companies of the second and third divisions will wheel to the left and right, on the direction of their company commanders, to form the second and third fronts of the square.

The last division will face by the rear rank, on the command of the division commander, to form the fourth front.

(Casey's School of the Battalion, para 999)

Each set of double companies has a senior captain as its commander. When the companies wheel left and right and form "fronts" the senior captain of each front becomes the front commander. The Manual doesn't say how this command transition takes place. One would have to assume that as each company wheeled into its front, the front commander would take charge.

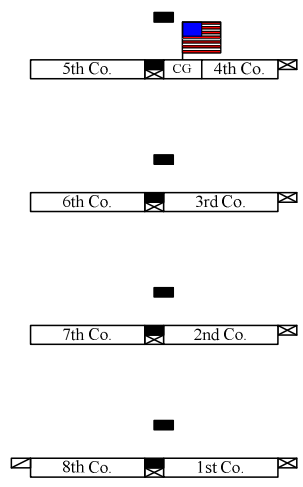

Figure 25
 1. "Form square."
 2. "Right and left into line, wheel."

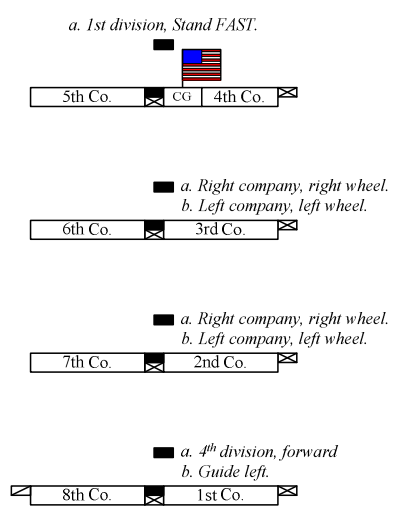

Figure 26
 1. "Quick - MARCH."

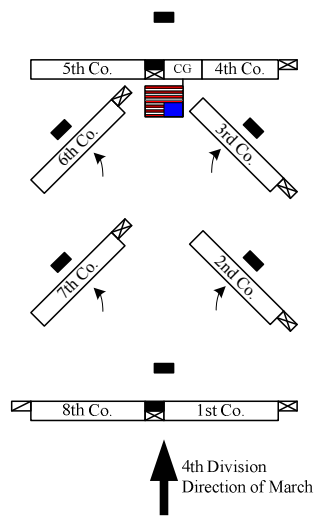
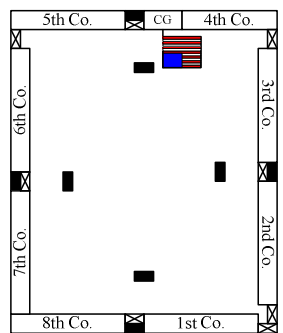

Figure 27



*a. 4th division, HALT
b. Right about, FACE.*

Figure 28

When the danger of cavalry has passed it is necessary to reduce the square to move the battalion. A battalion can not move more than 30 paces in a square formation. The square would fall apart in any movement and the battalion commander would lose control of the unit.

To reduce square and reform a double column of companies:

1. Form Column (or Reduce Square) (This command is sounded by the battalion commander)

The following cautionary commands are issued by the front commanders
First front: 1. First division, forward. 2. Guide left.

Fourth front: Stand fast

Second front: 1. Left Face. 2. By company, by file left.

Third front: 1. Right Face. 2. By company, by file right

When the companies of the second and third front face to the left and right, the company commanders will break three files to the rear. (Gilham's Manual p. 323)
This direction is not specified in Casey's Manual, but it must occur in order to properly move the companies into the center of the square.

3. MARCH (This is the command of execution sounded by the battalion commander). At this command all companies act on their front commander's orders.

The second front companies move by file left while the third front companies move by file right. The companies meet in the center and face forward to form a column of divisions.

(Casey's School of the Battalion, para. 1060 and 1086)

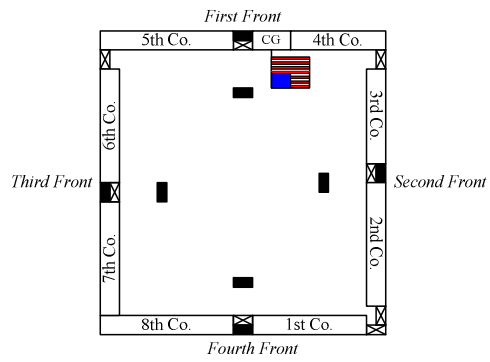

Figure 29
1. "Form Column."

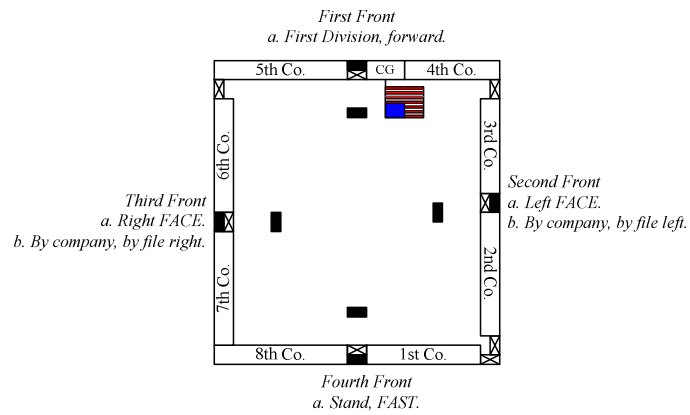

Figure 30

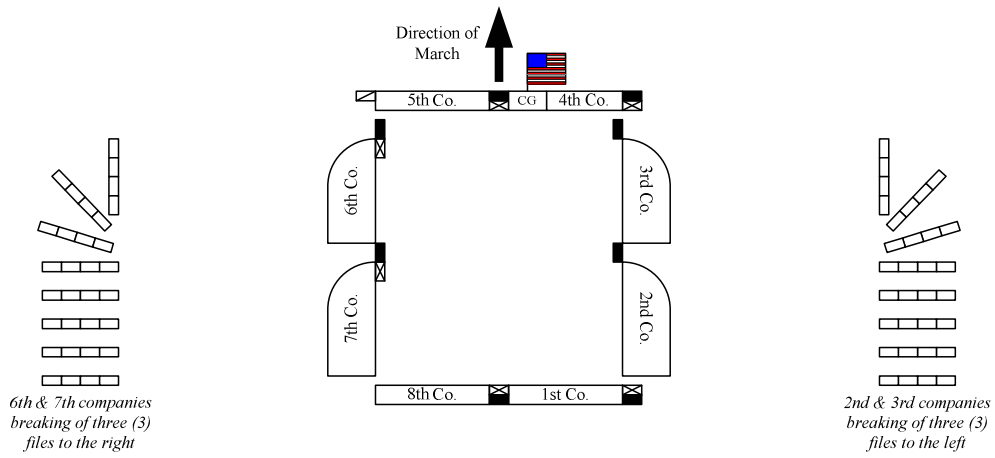

Figure 31
1. "MARCH."

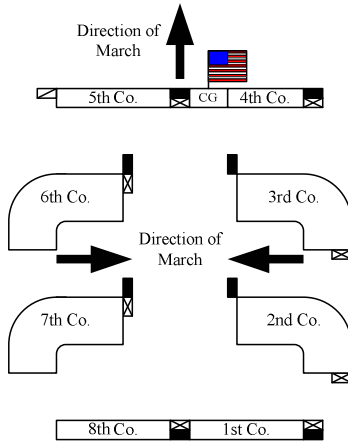

Figure 32

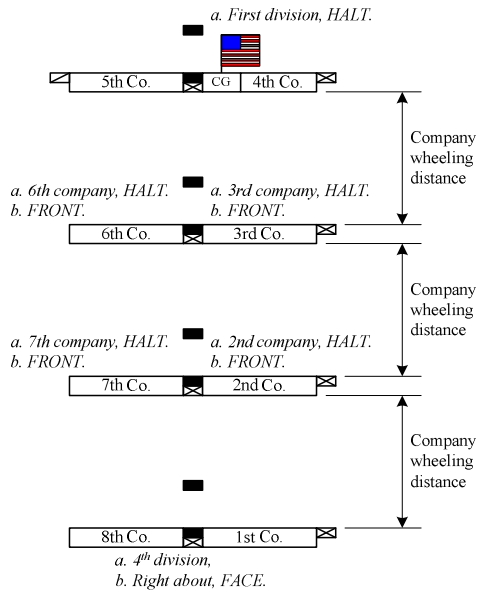

Figure 33